

Communication
Expert
Exceltel

PH202



User Manual

Please read this manual before using

Table of Contents

Chap 1	Specification	2
Chap 2	Panel Illustration	3
Chap 3	LCD Display	4
Chap 4	Shortcut key Definition	5
Chap 5	Installation	7
Chap 6	Using Guide	8
	1) Intercom Call :	8
	2) Outgoing Call	8
	3) Redial	8
	4) Speed Dial	9
	5) Call Transfer	9
	6) Call Hold	9
	7) Restore the holding call	9
	8) Multi-party Conference	10
	9) Function Key	10
	10) Alarm Clock Setting	10
	11) Call Forwarding	10
	12) Boss/Secretary	10
	13) DND Key	11
	14) Paging	11
	15) Auto Answer	11
	16) Mute Key	12
	17) Call Booking	12
Chap 7	Using Setting	13
	Take an example for how to set the 16 DSS keys corresponding to CO line	14
Chap 8	DSS Setting	16
	Take an example for how to set DSS12 to Ext. Port 008	16
Chap 9	Speed Dialing	18
	Take an example for how to set the number 008618923238930 to group No.20 of speed dialing	18
Chap 10	How to set multiple DSS to connect with keyphone	20
Chap 11	Connection for DSS	21

Chap 1 Specification

1. Wring Length : The length of connecting 1 keyphone to the KTS board should be < 250m ; Connecting 2 keyphones to the same KTS board should be <150m ; Connecting 4 keyphones to the same KTS board should be <50m .
2. Working Voltage : $32\pm 12\text{VDC}/50\text{mA}$
3. Weight : 0.8kg
4. Size : 22.8mm*18.3mm*12mm

Chap 2 Panel Illustration

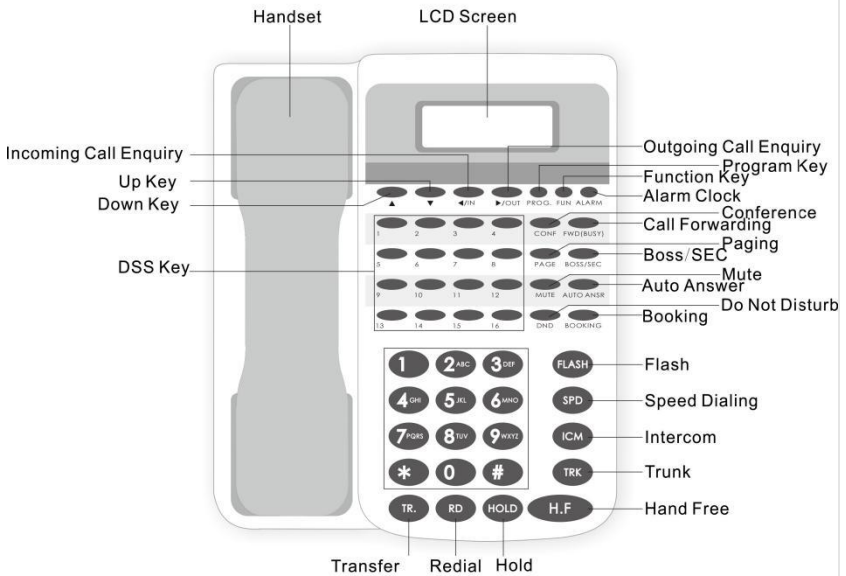

Chap 3 LCD Display

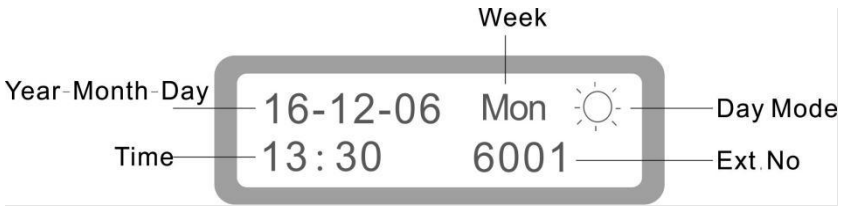

Chap 4 Shortcut key Definition

1. **DSS:** Direct Station Selection keys, PH202 with 16 DSS keys, on default, DSS1 -12 corresponding to CO line 1-12, DSS 13-16 corresponding to Ext port 1-4. On hook status, press DSS key, to call corresponding extension or access corresponding CO line.
2. **Direction key:** used to configure parameter. On hook status, the left and right arrow key are used for entering incoming/outgoing call query interface, the up arrow key is used for adjusting ring volume, the down arrow key is used for adjusting speaker volume
3. **PROG:** enter menu setting interface, including using setting, programming, DSS setting, Speed Dialing setting, press H.F key to exit menu.
4. **FUN:** fast enter operator setting, equal to the operation of off hook + #, end with H.F key
5. **ALARM:** set the alarm clock
6. **CONF:** During the call with CO line, press this key to hold this call as conference status
7. **FWD(BUSY):** when extension is busy, forward the incoming call to another extension, press this key, input extension number, prompt "operation succeed", meanwhile the indicator is on. Press again this key, input #, to cancel this setting.
8. **PAGE:** press this key + (0, broadcast by extension / 8, call all extension)
9. **BOSS/SEC:** auto forward the incoming call to another extension
10. **MUTE:** press this key, the microphone of key phone is closed, the light of keys is on, press again, cancel MUTE function, the light is off.
11. **AUTO ANSR:** press this key, when any call is coming, system will auto answer in speaker, press again, to cancel this function.
12. **DND:** press this key, the extension is in Do Not Disturb status, press again, to cancel this function.
13. **BOOKING:** press this key, equal to press #0, when booking is succeed, key light is on, after booking is performed, key light is off.
14. **Flash:** used in call switch for the call with CO line. Equal to flash the hook and dial #8 during the conversation with CO line .

-
- 15. SPD:** on hook status, press this key, and input speed dialing group number, to make speed dialing function. Off hook status, press this key, input system speed dialing group number, to make speed dialing function.
 - 16. ICM:** press this key, system is in intercom status, the light is on

 - 16. TRK:** press this key, system is in CO line access status, the light is on, equal to off hook + 9
 - 17. TR.:** press this key, and input another extension number, to transfer the call to another extension.
 - 18. HOLD:** during the call with C.O line, press this key, to hold the current call, after finish the call with another C.O line, press corresponding DSS key, to continue with previous call
 - 19. RD:** off hook, press this key, system will auto call the last dialed number. You can select incoming/outgoing call records to press redial.

Chap 5 Installation

Using four wires cable to connect key phone with 8 port KTS card ports of TP256 directly. One RJ45 port can connect with 2 key phone .

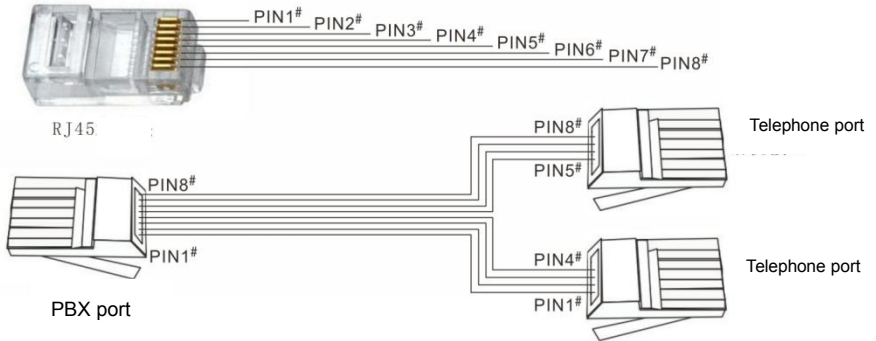

When user need to lengthen the cable or make a 4 wire cable by himself, he should be attention to the sequence of cable: the two wires on middle are signal line . Pin1 and pin4 are data line. If wrong connection, the key phone will not work. Furthermore make sure good contact and correct line sequence when make the RJ11 crystal connector.

Chap 6 Using Guide

1) Intercom Call :

- ① off hook + Ext.No + talking

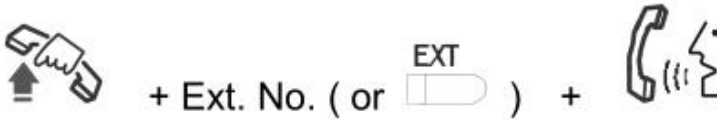

- ② dial DSS key directly
③ dial ICM key + Ext.No + talking

2) Outgoing Call





- ① off hook+ CO. DSS key + external number + talking







- ② dial DSS key directly
③ dial TRK key + external number + talking

3) Redial



- ① Incoming call redial : press  + talking

- ② Press  +  or  to query the incoming number +  +talking

- ③ Outgoing call redial

Press /OUT +  or  to query the outgoing call number +  +talking

4) Speed Dial

- ① Press  +the group number of speed dialing stored on key phone(01-32)
- ② off hook + Press  +the group number of speed dialing stored on the PBX (01-96)

5) Call Transfer

When talking with CO line or Extension +  + Ext.No or DSS key + on hook

6) Call Hold

During the conversation and dial  key to hold the conversation.Then key phone can enter intercom call status .

When hold the call from CO line , the CO LED will slow-flash .And when hold the call from intercom, if key phone don't hang up , the light of ICM key will be on .

7) Restore the holding call

Restore the holding call from CO.line : press the certain CO line key or press 

Restore the holding call from extension : press  directly

8) Multi-party Conference

During the conversation with CO line ,after press the key ,system will enter in conference status.



9) Function Key



FUN + programming code

Function key means your dial *#. It works for the programming code without enter programming status .

Eg. Setting the system time to 12:30:20 am



FUN +01 (time setting code) +123030(time)

10) Alarm Clock Setting



ALARM + time

11) Call Forwarding



When Ext is busy or no answer : FWD(BUSY) + Ext.number



Cancel : FWD(BUSY) + #

Noted : Press this key, and dial the Extension number , it will display " operation OK",and the LED will be on . After cancel it , the LED will be off .

12) Boss/Secretary



Forward the call to Ext.N directly : BOSS/SEC + Ext.number

Cancel : BOSS/SEC + #

Note: press this key, and input an extension number, will display "operation OK", and the LED will be on . After cancel it, the LED will be off.

13) DND Key

DND(Do not Disturb) : After press this key , it will enter DND status . If press again, it will cancel .

14) Paging

External Broadcast :  +0 (equal to #86)

Monitor CO line:  +1+ CO line port (equal to #71+CO line port)

Monitor extension :  +2+extensions number (equal to #72+extension number)

Notes : If you want to monitor the intercom and external line from key phone, you need to set the key phone as operator .

Key phone Broadcast :  +3(all key phone will ring together and auto answer)

Emergency broadcast:  +8 (all extension will ring together and all key phone will auto answer)

15) Auto Answer

Auto Answer :  the LED will be on

 Cancel : AUTO ANSR the LED will be off

16) Mute Key

 Mute : MUTE the LED will be on

 Cancel: MUTE the LED will be off

17) Call Booking

 Call Booking : BOOKING the LED will be on



 Cancel : BOOKING the LED will be off



Chap 7 Using Setting

Pressing **PROG.** one time, then system will enter USING SETTING status.
LCD shows as follow :



User Set

Language

1) You can press the key  or  to select the items .Like “Language”, “Backlight Setting”, “Ext Ring”, “CO.Ring”, “Doorphone Ring”, “Alarm Ring”, “System Query “, “ Reset Keyphone” etc.

2) You can press the key /IN or /OUT to set the selected item.
Eg.: when you select “ Language ”, you can select English ,Italiano,Turkish,中

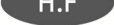
文.After finish, press  to save .

3) Press  one time ,will back to the current status . And press  twice , will back to home page.

Take an example for how to set the 16 DSS keys corresponding to CO line

◆ Step 1: Press  **PROG.** one time and enter setting status .

User Set
Language

◆ Step 2: Press  7 times or press  one time .Show as below:

User Set
Reset Keyphone

◆ Step 3: Press  **/OUT** one time. Show as below :

Reset Keyphone
01

Input 16 and press , then you will hear beep and it means save successfully .

The Option of User Setting and its suboption as below:

- 1) Language
Option:中文 / English / Italiano /TURKISH
- 2) Backlight Setting
Option : Auto / On / Off
- 3) Ext Ring
Option : 01 to 16
- 4) CO. Ring

Option : 01 to 16

5) Doorphone Ring

Option : 01 to 16

6) Alarm Ring

Option : 01 to 16

7) System Query

You can see the version number and outgoing mode

8) Reset Keyphone

Option : 00 to 32 (CO.Line)

Chap 8 DSS Setting

Take an example for how to set DSS12 to Ext. Port 008



◆ Step 1 : Press . three times and enter DSS status . Show as below



DSS

001 TRU 01

Remark :

001, it means the number of the DSS button (001 means it is the first DSS button) . TRU means it was set for CO line (It has two options , TRU and EXT .



You can use  or  to select it .) 01 ,means it is the port number of CO line and Extension (and it means the first CO line port). All that means it is the first DSS button corresponding to the first CO line port

◆ Step 1 : Pressing the key /IN or /OUT to select the number of DSS and input 012 Or dial the No.12 DSS on the keyphone .

DSS

012 TRU 012

◆ Step 3 : Press /OUT and go the second part TRU . You can use

 or  to select to EXT . Show as below

DSS

012 EXT 012

◆ Step 4: Press **▶/OUT** to go to the third part 001 and input 008 on the keyphone . Show as below.

DSS

012 EXT 008

◆ Press **HOLD** to save and will hear beep tone .

◆ Press **H.F** to back to the home page.

Chap 9 Speed Dialing

Press **PROG.** 4 times , and show as below .



A rectangular box representing a screen. On the left side, the text "Speed Dial" is displayed. On the right side, the number "01" is displayed.

Press **▼** or **▲** to select the group number of speed dialing . It is range from 01 to 32 . Or it can dial the two digit group number .

After selecting the group number , then press **▶/OUT** to input the number you want.

Take an example for how to set the number 008618923238930 to group No.20 of speed dialing

◆ Step 1 : press **PROG.** four times to enter speed dial status .



A rectangular box representing a screen. On the left side, the text "Speed Dial" is displayed. On the right side, the number "01" is displayed.

◆ Step 2 : Press **▼** or **▲** to set the number to 20 . Or input 20 directly .



A rectangular box representing a screen. On the left side, the text "Speed Dial" is displayed. On the right side, the number "20" is displayed.

◆ Step 3 : Press **◀/IN** or **▶/OUT** to enter input status and input the number directly "008618923238930"

Speed Dial 20
008618923238930

◆ Step 4 : Press **HOLD** to save

◆ Step 5 : Press **H.F** to back to home page.

Chap 10 How to set multiple DSS to connect with keyphone

1) Setting a DSS to No.2 DSS . Programming as below

- ① Connected the keyphone and PBX
- ② Always-press the second button of No.DSS
- ③ At the same time ,remove the cable between No.1 DSS and keyphone and connect again .
- ④ Don't loosen the second,until the first and second green LED of No.2 DSS light .
- ⑤ Re-connected the PBX and keyphone again .When the first and second green LED of No.2 DSS light together , that means it is the No.2 DSS

2) If you want to No.3 and No.4 DSS , repeat the last step . But when setting No.3 DSS , you should always-press the third button . And when setting No.4 DSS , you should always-press the fourth button .

3) How to distinguish the DSS number .

When connected the PBX and keyphone , if the DSS is No.1 DSS , the first button will light . If it is No.2 DSS , the first and second button will light together . If it is No.3 DSS , the first , second and third button will light together . If it is No.4 DSS , the first , second , third and fourth button will light together .

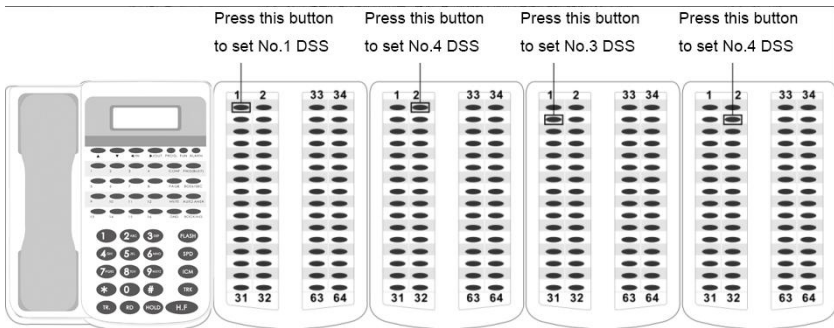

Chap 11 Connection for DSS

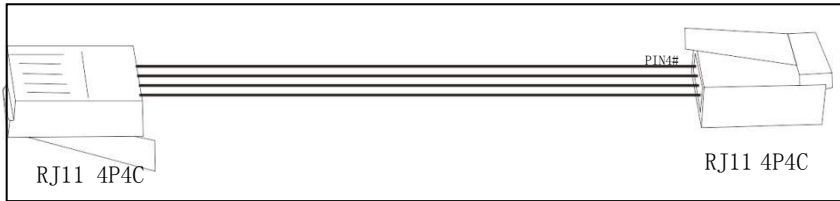

Smarteck Electronics
Telecommunications & Security Solutions

Pelasgias 85 Athens Greece 12136

Tel: +30 2105771577

E-mail: info@smarteck.gr Web: www.excelltel.gr

www.excelltel.gr