

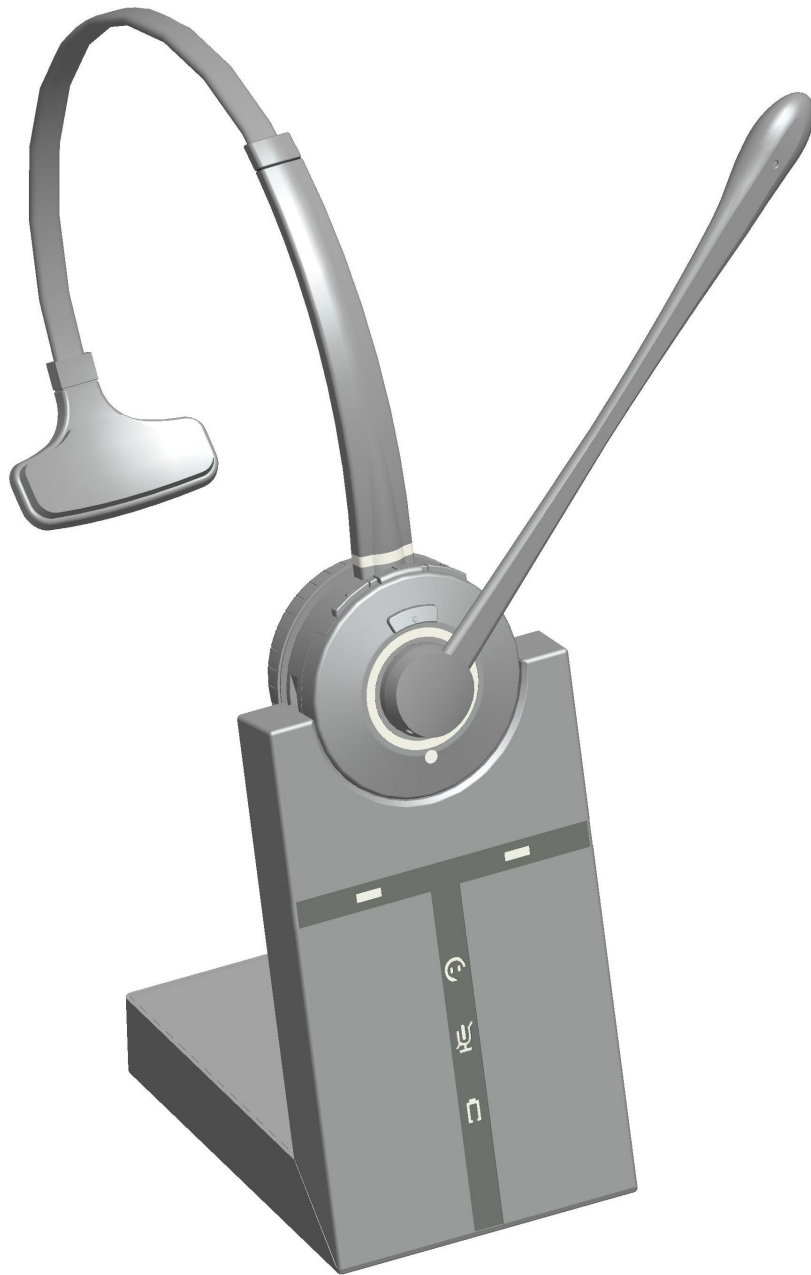

VT 9000 DECT



User Manual

1. WELCOME.....	3
2. PRODUCT OVERVIEW.....	4
2.1 PACKAGE CONTENTS.....	4
2.2 HEADSET OVERVIEW.....	5
2.3 BASE OVERVIEW.....	6
3 CONNECTING TO A DESK PHONE.....	7
3.1CONNECT TO DESK PHONE.....	7
3.2 CONNECT POWER SUPPLY TO BACE.....	8
3.3 DOCK THE HEADSET.....	8
4. CONFIGURING THE DESK PHONE AUDIO.....	9
4.1 SET A CLEAR DIAL TONE.....	9
4.2 SET THE MIC, RECEIVER VOLUME.....	9
5. VT9000 DECT FEATURES.....	10
5.1 HEADSET MULTI-FUNCTION BUTTON.....	10
5.2 HEADSET RECEIVER VOLUME BUTTONS.....	10
5.3 HEADSET MUTE BUTTON.....	10
5.4 HEADSET LED INDICATORS.....	11
5.5 HEADSET AUDIO INDICATORS.....	12
5.6 BASE VISUAL INDICATORS.....	13
6. CALL MANAGEMENT.....	13
6.1 MAKING CALLS, ANSWERING CALLS AND ENDING CALLS.....	13
6.2 SWITCHING BETWEEN PHONE AND HEADSET.....	14
6.3 CONFERENCE CALL WITH MULTIPLE HEADSETS.....	14
7. TECHNICAL SPECIFICATIONS.....	15
7.1 VT9000 DECT HEADSET.....	15
7.2 HEADSET BATTERY.....	16
7.3 VT9000 DECT BASE.....	16
7.4 PRODUCT DISPOSAL.....	17

1. WELCOME

Congratulations on purchasing your new VT9000 DECT. We are sure you will enjoy its wide range of features, and find the headset comfortable to wear and easy to use.

VT9000 DECT headset features

- Wideband audio for exceptional sound quality.
- Volume and mute controls.
- Intuitive headset multi-function button for easy call handling.
- LED and audio indicators.
- Advanced hearing protection with safetone™.
- Noise-canceling microphone.

VT9000 DECT base features

- Headset recharge docking cradle.
- Visual call status indicators.
- Visual wireless connection status indicators.
- Mute indicators.
- Battery indicators.
- Voice-prompted configuration.
- volume adjustment
- Port for VT Link adapter and remote handset lifter.

2. PRODUCT OVERVIEW

2.1 PACKAGE CONTENTS



Headset

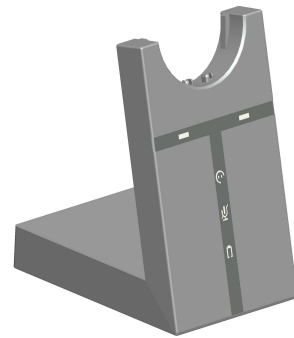

Base

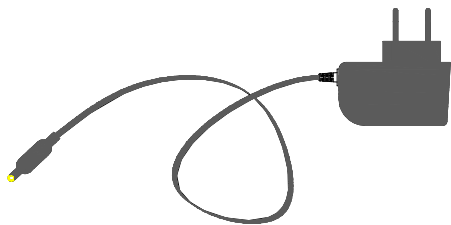

Power adapter



User manual

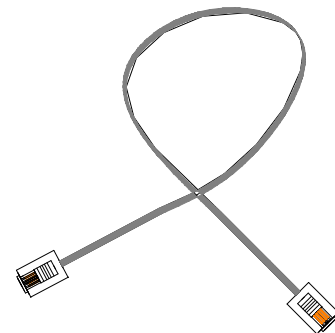

Telephone cable

2.2 HEADSET OVERVIEW

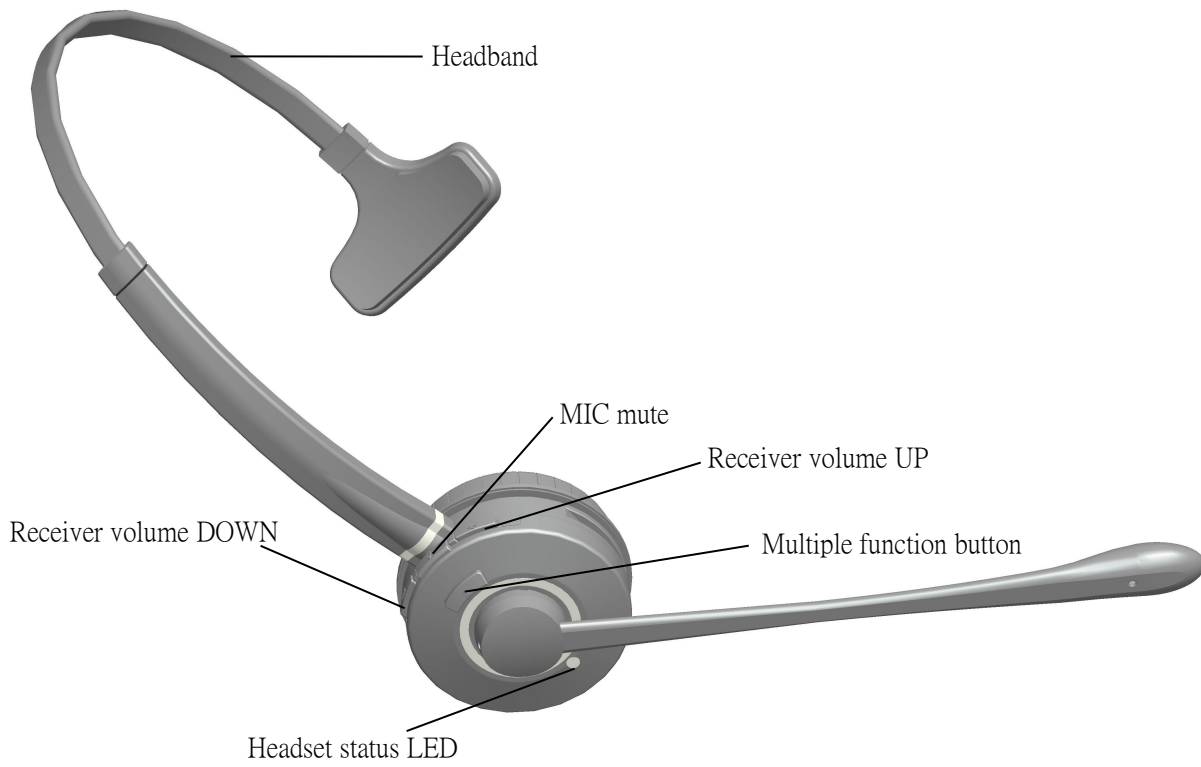

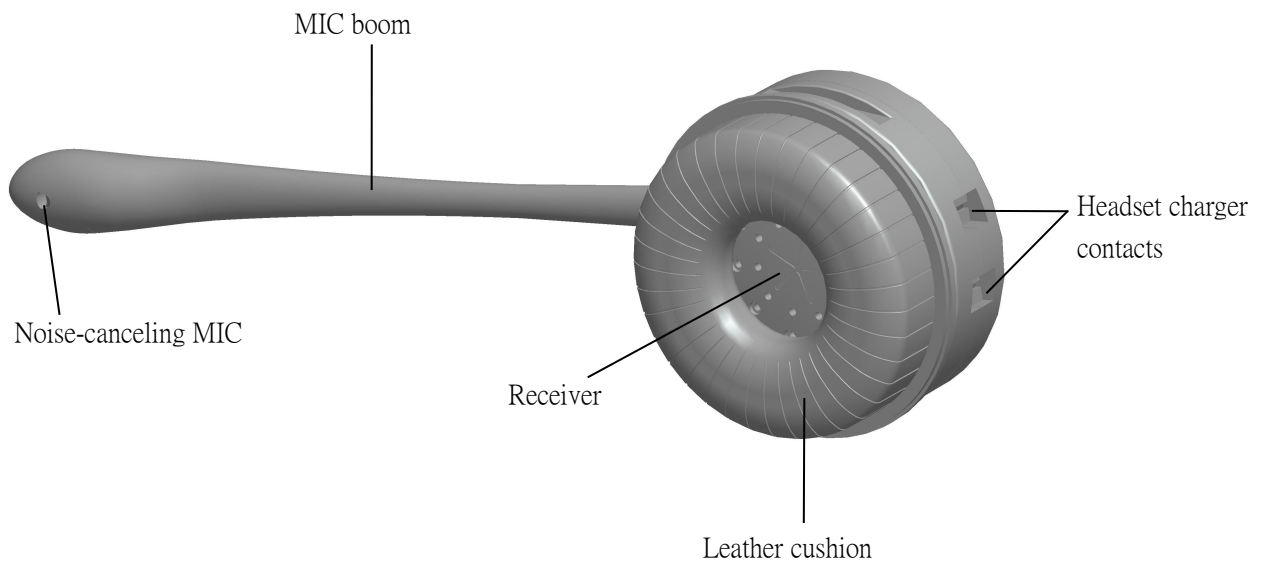

2.3 BASE OVERVIEW

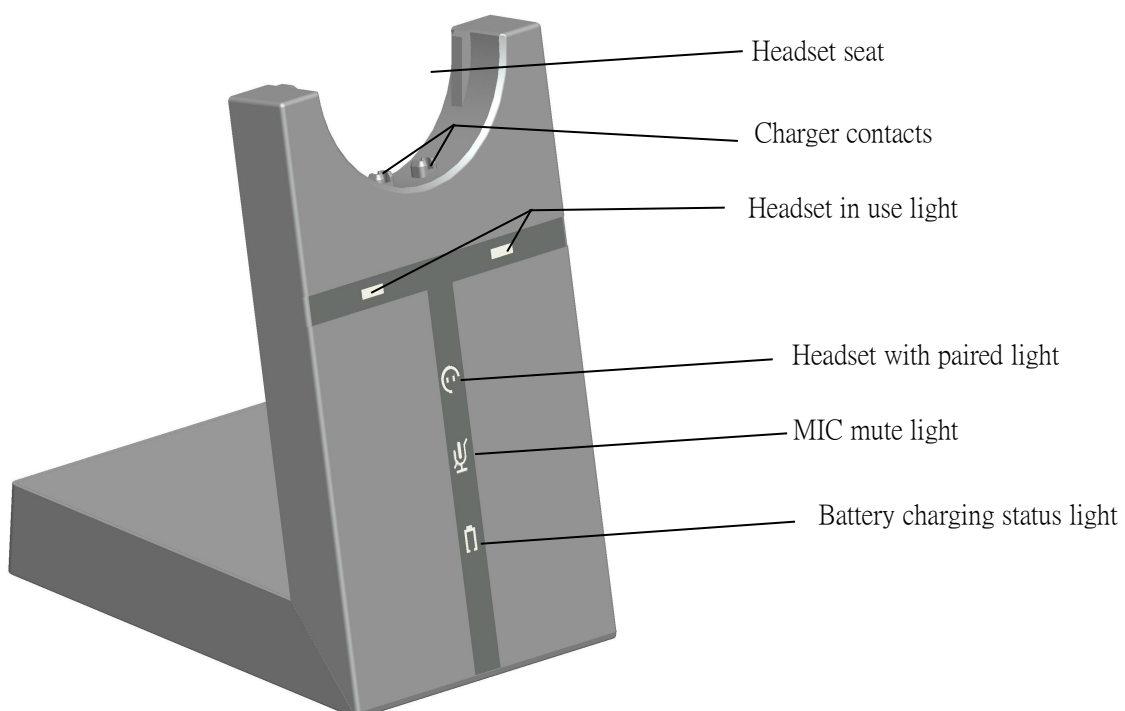

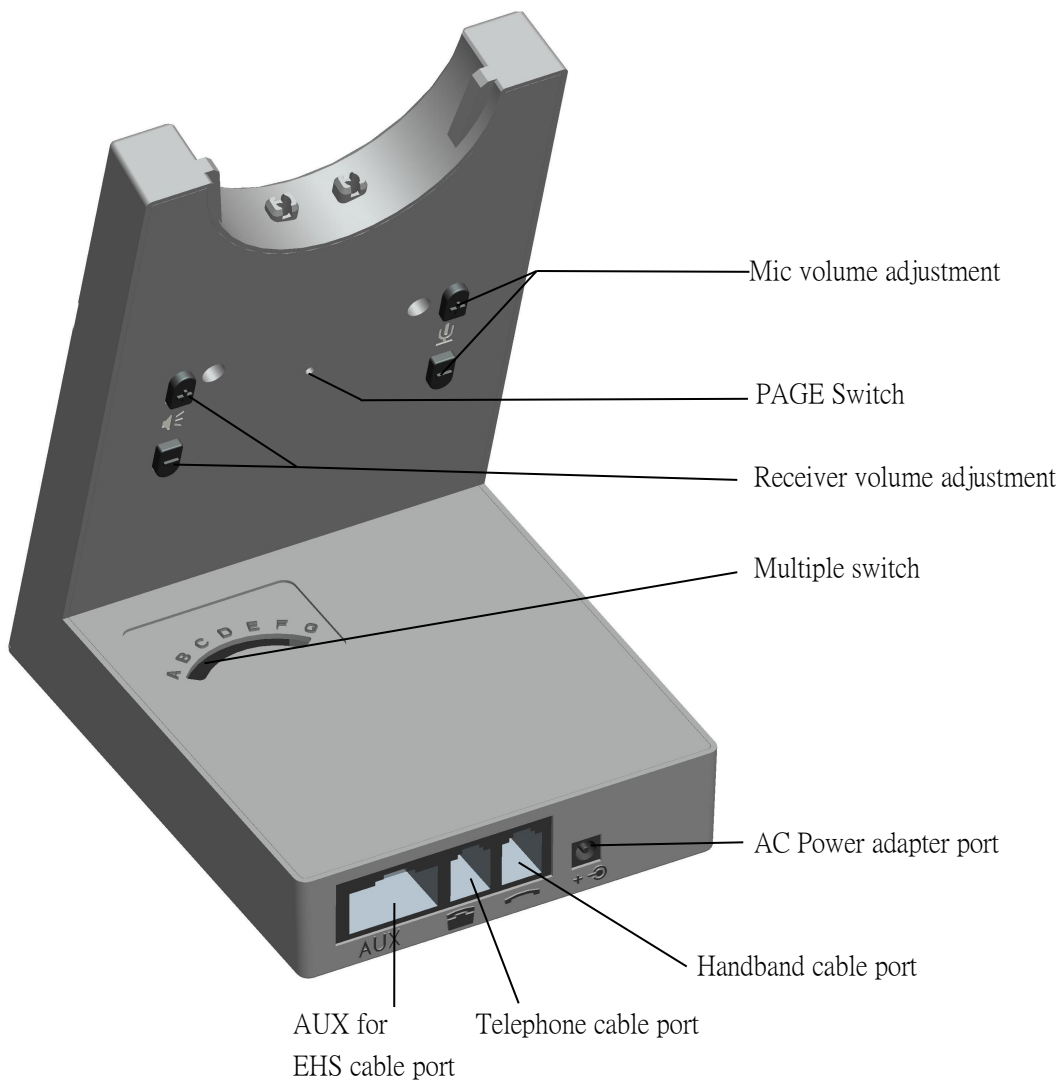



3 CONNECTING TO A DESK PHONE

3.1 CONNECT TO DESK PHONE

Option 1

Desk Phone without Headset Port:
this desk phone does not have a dedicated headset port.

1. On the desk phone, unplug the handset cable from the phone body.
2. Connect the handset cable to the port marked  on the base.
3. Plug the supplied telephone cable into the port marked  on the base.
4. Connect the telephone cable into the handset port on the desk phone.

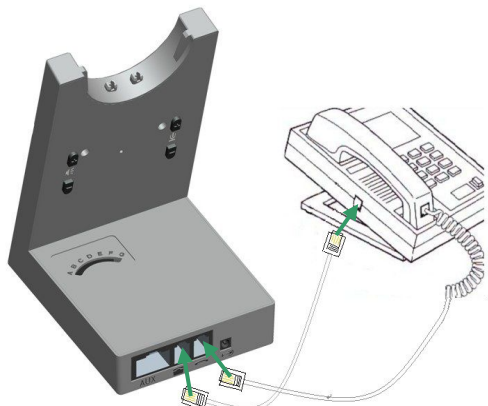

Option 2

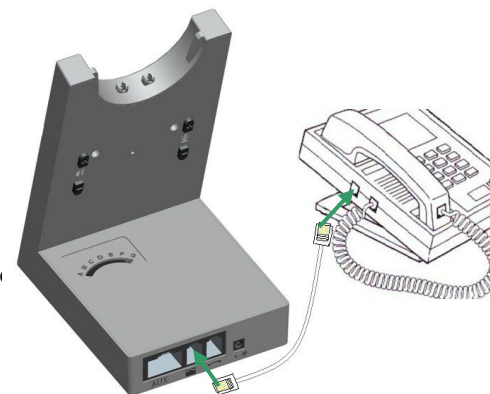

Desk Phone with Headset Port:
This type of desk phone has a dedicated headset port(usually at the back of the phone). These phones typically have a button on the front panel for switching Between handset and headset.

1. Plug the supplied telephone cable into the port marked  on the base.
2. Connect the telephone cable to the headset port on the desk phone.



Option 3

Desk Phone with Lifter the remote handset:
lifter manually lifts the desk phone handset to make or answer a call. For mounting Instructions refer to documentation supplied with the lifter.

1. On the desk phone, unplug the handset cable from the phone body.
2. Connect the handset cable to the port marked  on the base.
3. Plug the supplied telephone cable into the port marked  on the base.
4. Connect the telephone cable into the handset port on the desk phone.
5. Connect the Lifter cable into the port marked **AUX** on the base.

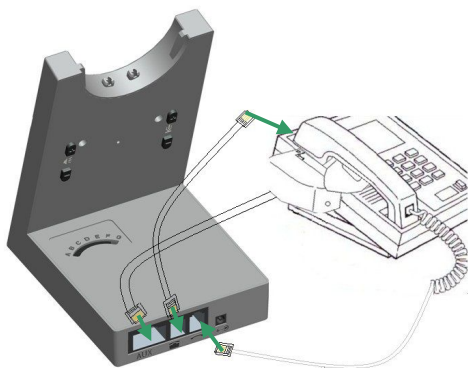

Option 4

Desk Phone with VT Link:
A VT Link adapter enables an incoming call to be answered or ended by the headset multi-function button.

Contact your local VT dealer to purchase a VT Link adapter for your specific desk phone.
1. Connect the VT Link adapter as shown in adapter documentation supplied with the VT Link. On some phones the telephone cable will also need to be connected.

2. Call your connected desk phone using another phone to enable the VT Link adapter. Wait 10 seconds before answering the phone.

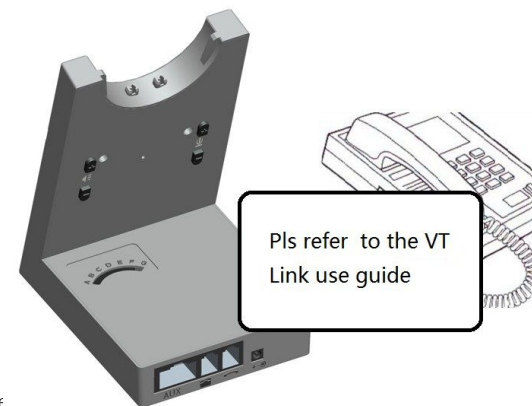

3.2 CONNECT POWER SUPPLY TO BASE

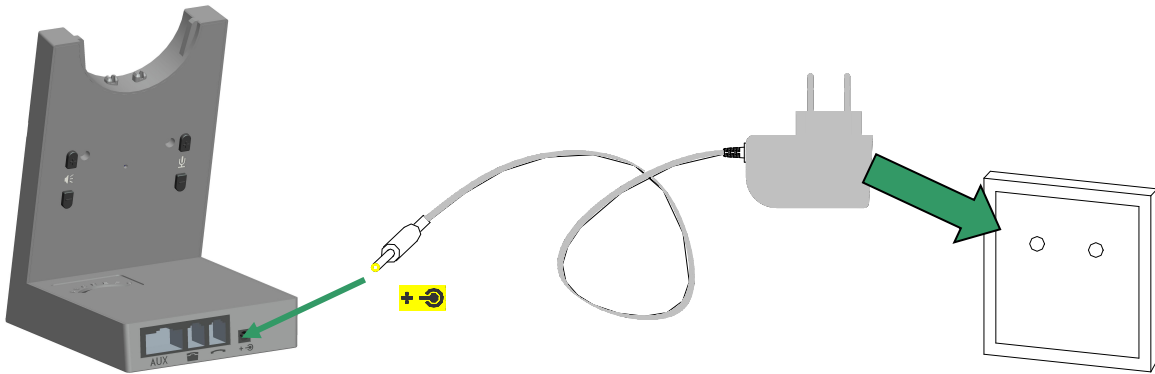

1. Plug the power adapter into the port marked  on the base.
2. Connect the power adapter to the mains power socket.

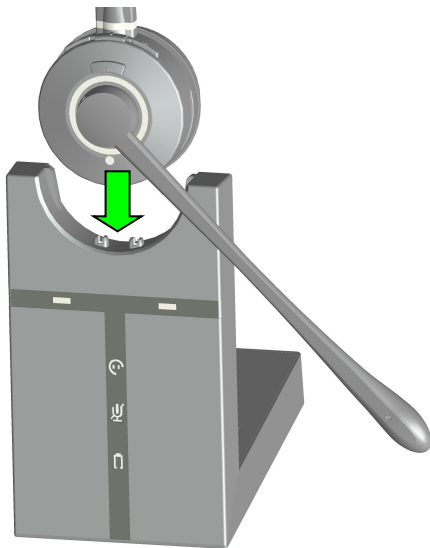

3.3 DOCK THE HEADSET

1. Press the Multiple function button, it will be powered on after the LED lights for 2S. Press the Multiple function button again or dock the headset with the base, then lifting the headset, the headset with paired light  will lit up when the headset and base are in the connection.



2. When docked correctly the headset battery will begin charging, if needed(LED will flash when charging ). Charge for 20 minutes or until the battery indicator on the base  is steady green.
3. Clear the paired base: Press the marked R+ at the back of the base, the battery charging status light will flash 3 times.
4. Renew to pair the headset: consistently press the PAGE switch for 5S, the headset with paired light  will flash to search the headset, consistently press the headset mute button until the headset status LED flash, then the headset are in the paired status. Connection will be successful when the LED power off in the same time.

4. CONFIGURING THE DESK PHONE AUDIO



Due to the large range of desk phone brands/models available, a clear dial tone must be set before first-time use of the VT9000 DECT. setting the clear dial tone will enable the VT9000 DECT to function correctly with your specific desk phone. additionally it is also important to set the microphone volume for optimal sound quality.

4.1 SET A CLEAR DIAL TONE

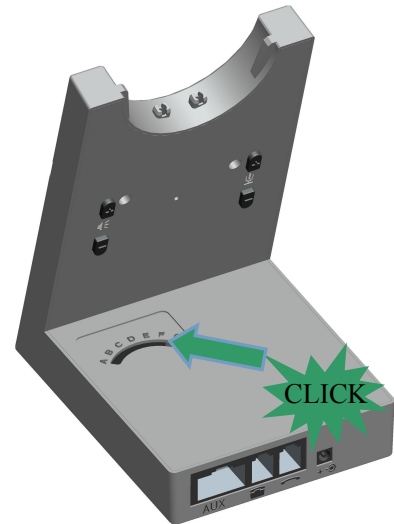
1. Put on the headset.
2. Get a dial tone by pressing the headset button on the desk phone, or by lifting the desk phone handset.
3. Locate the clear dial tone switch on the back of the VT9000 DECT base, as illustrated, and while listening in the headset for a clear dial tone, rotate the switch from a to G.
4. Determine the best switch position. The dial tone should be strong, clear and undistorted.
5. When the clear dial tone is set, press the headset button on the desk phone, or return the desk phone handset to the receiver.



4.2 SET THE MICROPHONE VOLUME

1. Put on the headset.
2. Get a dial tone by pressing the headset button on the desk phone, or by lifting the desk phone handset.
3. Make a test call. Call a friend or colleague to test your speaking volume. ensure the listener does not adjust their own volume.
4. Adjust the microphone volume using the microphone  + / - volume buttons, as illustrated, if your speaking volume is too loud or too quiet for the listener.
5. Adjust the receiver volume using the receiver  + / - volume buttons, as illustrated, if your listening volume is too loud or too quiet by the listener.
6. When the microphone volume is set, end the call.

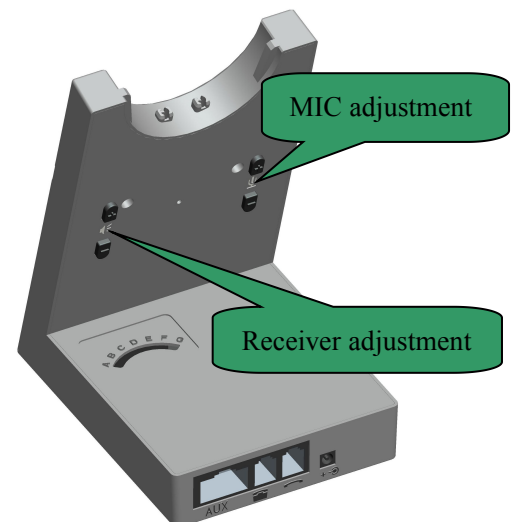

5. VT9000 DECT FEATURES

5.1 HEADSET MULTI-FUNCTION BUTTON

The multi-function button can answer calls and end calls using a combination of taps, double-taps or presses .

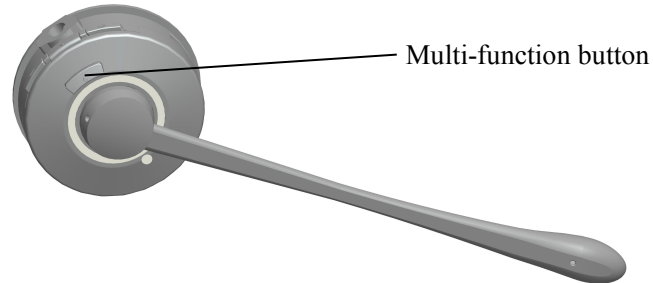

Function	Tap	Press hold
Answer incoming call	√	
End current call	√	
Power on	√	
Power off		√

5.2 HEADSET SPEAKER VOLUME BUTTONS

The speaker volume buttons adjust the headset speaker volume.

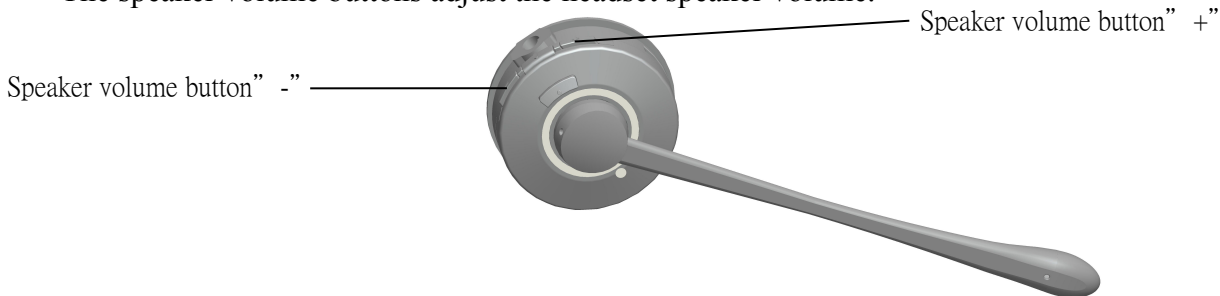

5.3 HEADSET MUTE BUTTON

The mute button mutes or un-mutes the headset microphone.

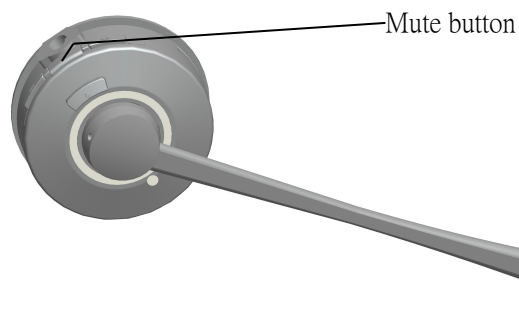

Function	Tap	Press Hold
MIC muting	√	
Mute Canceling	√	
In the paired status		√

5.4 HEADSET LED INDICATOR



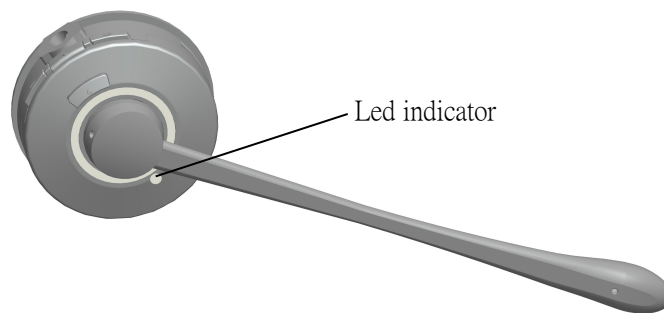





The LED indicator indicates call status.



Headset state	LED Indicator
Power on	Blue LED on for 2S
Power off	100ms on, 100ms off, then Flash 3S
Pairing	Flash(250ms ON , 250ms OFF alternately)
Standby	Flash(250ms ON,8s OFF alternately)
Connected	Blue LED
Online	Blue LED
Incoming call	Flash(300ms ON, 700ms OFF alternately)
Headset docked in base(charging)	Flahs(3S ON ,5S OFF alternately)
Low battery clarming	Flash(300ms ON , 100ms OFF+300ms ON 500 OFF alternately)

5.5 HEADSET AUDIO INDICATORS

The headset plays a variety of voice announcements and audio tones to indicate headset status and actions.

Headset status	Sound prompt
button tap	 volumeUpDown.wav
Maximum/Minimum speaker volume	 error.wav
Mic muting	 mute.wav
Audio connection	 rangeIn.wav
Off connection	 rangeOut.wav
Incoming call	 ring.wav
battery low	 battlow.wav
Out of range	 error.wav

5.6 BASE VISUAL INDICATORS

The VT9000 DECT base has five LEDs to indicate battery, call status and events.

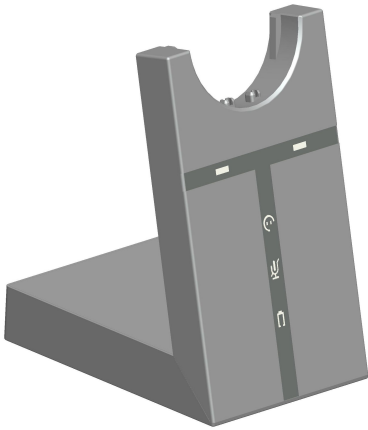

Icon	Status
	Online
	Link between headset and base
	Searching for headset
	Microphone muted
	Battery charging
	Full battery
	Unknown battery status

6. CALL MANAGEMENT

6.1 MAKING CALLS, ANSWERING CALLS AND ENDING CALLS

	Phone without headset port	Phone with headset port	Phone with VT Link, or Lifter
Make call	<ol style="list-style-type: none"> Lift headset from docking cradle, or tap the multi-function button. Lift desk phone handset and set aside . Dial number using desk phone. 	<ol style="list-style-type: none"> Lift headset from docking cradle, or tap the multi-function button. Tap the headset button on the desk phone. Dial number using desk phone. 	<ol style="list-style-type: none"> Lift headset from docking cradle, or tap the multi-function button. Tap the headset button on the desk phone. Dial number using desk phone.
Answer call	<ol style="list-style-type: none"> Lift headset from docking cradle, or tap the multi-function button. Lift desk phone handset and set aside . 	<ol style="list-style-type: none"> Lift headset from docking cradle, or tap the multi-function button. Tap the headset button on the desk phone. 	<ol style="list-style-type: none"> Lift headset from docking cradle or tap the multi-function button.
End call	<ol style="list-style-type: none"> Pick off the headband of the desk phone ; Dock the headset, or tap the multi-function button call. 	<ol style="list-style-type: none"> Tap the headset button on the desk phone Dock the headset, or tap the multi-function button call. 	Dock the headset, or tap the multi-function button call.

6.2 SWITCHING BETWEEN PHONE AND HEADSET

Switch from desk phone to headset

1. Lift headset from docking cradle.
2. Do not return desk phone handset to receiver, as this will hang up the call.

Switch from headset to desk phone (without VT Link or Lifter)

1. Lift desk phone handset.
2. Dock headset, or tap the multi-function button.

Switch from headset to desk phone (without VT Link or Lifter)

1. Lift desk phone handset.
2. Refer to specific desk phone documentation. In some cases a button must be pressed on the desk phone, while in others the switch from handset to desk phone will be automatic.

6.3 CONFERENCE CALL WITH MULTIPLE HEADSETS

The VT9000 DECT is able to pair with four headsets in total for conferencing: one primary and three secondary headsets.

Connect the headset:

1. Consistently press the PAGE switch for 5S, the headset with paired light  will flash to search the headset, consistently press the headset mute button until the headset status LED flash, then the headset are in the paired status. Connection will be successful when the LED power off in the same time.
2. Repeat the procedure 1 to connect the four pieces of headsets.

Conference call

1. Press the multiple function button to connect the headsets, then the audio will be shared between the headsets.
2. Dialing to enter the conference call.

Ending or leaving the conference

The headset user can hang up the phone call to end the conference. At the same time, all headset calls are ended.

7. TECHNICAL SPECIFICATIONS

7.1 VT 9000 DECT HEADSET

Operating environment:

0°C to +40°C; Up to 95% Rh non-condensing.

Call control:

Multi-function button support for answer call, end call, reject call, docking operations also answer and end calls.

Volume control and microphone mute:

button controls on headset.

Visual indicator:

LED indicates call status, pairing status and other events.

Audio indicators:

Tones indicate incoming calls, low battery, volume level, microphone muting and other events.

Sound quality:

DSP noise reduction; echo cancellation; tone control; wideband and narrowband audio.

Recharge:

While docked in the VT 9000 DECT Headset.

Wireless standard:

(CAT - IQ) European DECT and U.S. DECT.

DECT range:

For European DECT, up to 120 meters from VT 9000 DECT Headset base to headset.

For U.S. DECT, up to 350 feet from VT 9000 DECT Headset base to headset.

DECT frequencies:

US DECT: 1.92 - 1.93 Ghz.

EU DECT: 1.88 - 1.90 Ghz.

Wearing-styles:

Headband and ear hook

Microphone boom arm style:

Long boom arm °

Speaker(s):

Wideband speaker.

Microphone:

noise-cancelling microphone.

7.2 Headset Battery

Battery type:

Lithium Ion-polymer.

Battery capacity:

300 ma/h, typical.

Battery talk time:

Up to 8 hours.

Battery lifetime:

Minimum 1000 charge cycles.

Battery standby time:

At least 36 hours.

Operating temperature range:

-20°C to +60°C.

Battery charge time:

20% charge in less than 20 minutes.

50% charge in less than 45 minutes.

Full charge in less than 3 hours.

Battery shelf life:

headset battery holds charge for 6 months in the off state, before recharge is required.

7.3 VT 9000 DECT BASE

VT 9000 DECT base meets the following specifications.

Dimensions:

97mm x 75 mm x 120 mm °

Wireless standard:

(CAT - IQ) European DECT and U.S.DECT.

Operating environment:

-0°C to +40°C; Up to 95% Rh non-condensing.

Recharge cradle:

Fits supplied VT 9000 DECT series headset.

Desk Phone connections:

RJ-11 for handset, RJ-11 for phone body (or headset port), RJ-45 for AUX (for VT Link or lifter).

Clear Dial tone switch and microphone volume switch:

electromechanical switches. Clear dial tone switch and microphone volume level set manually.

7.4 PRODUCT DISPOSAL

Please dispose of the headset according to local regulations and recycle when possible. Do not dispose as household waste. Do not dispose of the headset in a fire as the battery may explode. batteries may also explode if damaged.